

TouchDMIS

THE MEASURING TOUCH

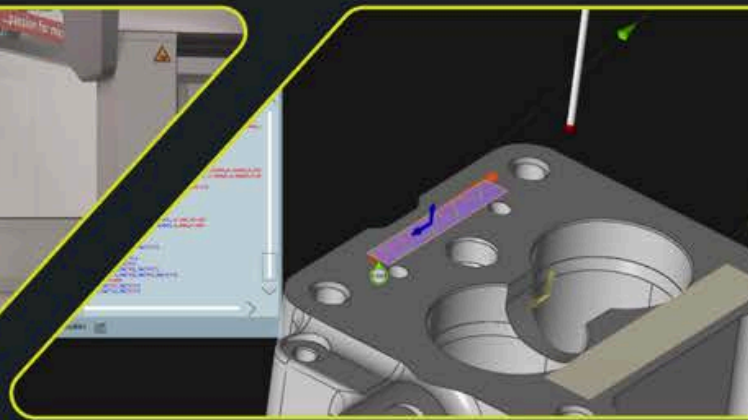
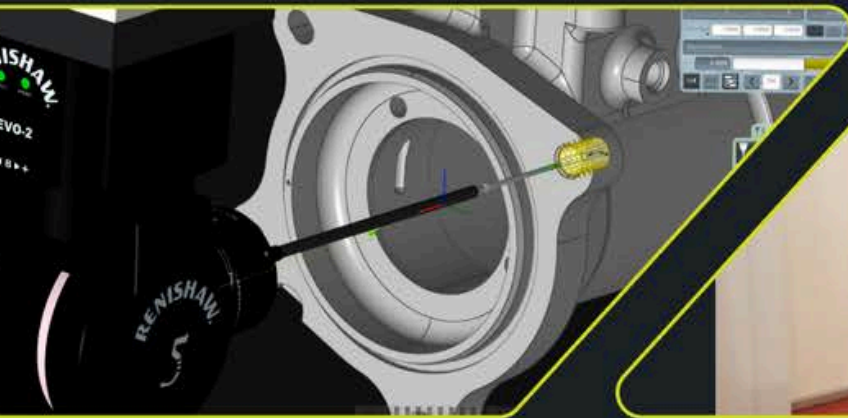

TouchDMIS 10
Service Pack 1

what's new
release notes











s.o.l.u.t.i.o.n.s

TouchDMIS 10

Service Pack 1

ver. 10.1.0.30

	What's new?	1
	Installation	12
	What we have improved	14
	Changes and improvements in SP1	16
	Fixed bugs	20
	Fixed bugs in Service Pack 1	23
	Supported Hardware & Drivers	25
	PC specifications	27
	TouchDMIS contacts and official channels	28



Information about this release

Dear users, operators, clients, and distributors,

This document introduces and highlights the latest innovations and improvements of TouchDMIS.

This release marks our commitment to provide a **state-of-the-art CMM software**, led by the latest innovation in the market and **Industry 5.0**.

One of the most notable is our new **Environment-Friendly Mode**, which allows the CMM to automatically switch off the air supply when the software is in standby, contributing to a more sustainable workflow.

We're also proud to announce a **new technical collaboration with PATLITE**, the **world's leading manufacturer of signal and machine lighting devices**. This partnership is aimed at enhancing the operator's daily experience through better visual communication and workflow support.

TouchDMIS 10 now supports **Renishaw REVO®** and **SFP2**, allowing operators to take full advantage of the REVO system's exceptional performance and precision.

To improve compatibility and performance, **we have modified some behavior of 5-axis systems in TouchDMIS (Renishaw® PH20 and REVO will be affected)**. In case you use this probe heads, please read the Additional Information of this document and the User manual.

And there's even more to discover.

Browse the following pages to explore all the new features and improvements in TouchDMIS 10.

Finally, we want to express our sincere thanks to our customers and distributors.

Your ongoing feedback is invaluable to our product development and continuous innovation.

The TouchDMIS team



Additional information - FYI

Important updates for 5-axis users (Renishaw® PH20 and REVO)

Release 10 introduces relevant changes to 5-axis system in TouchDMIS.

Now, when **All-axis mode** is active, in the CNC measuring settings you will find the **Front inclination** and **Side inclination** options, which replace the the **Tilt angle** and **Rotation angle**.

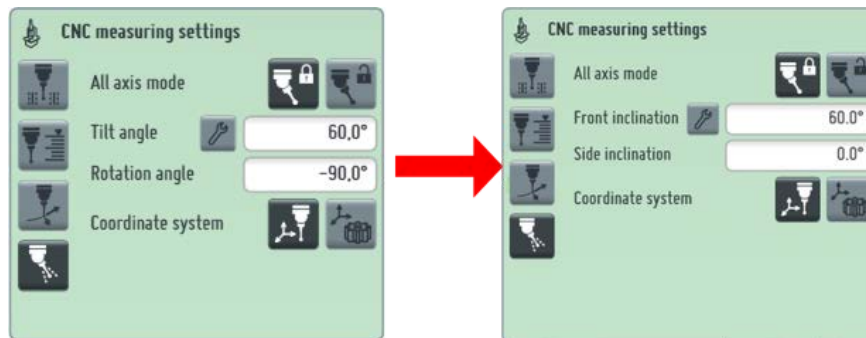

These changes affect the 5-axis probe head behavior. New parameter will define the orientation of the probe head during measurement.

Front inclination: sets the inclination of the probe head **relative to the first and second point to be measured** (rotation around Y)

Side inclination: sets the rotation of the probe head **relative to the first direction of the point** (rotation around X)

If Front inclination differs from 0°, Side inclination will be affected accordingly.

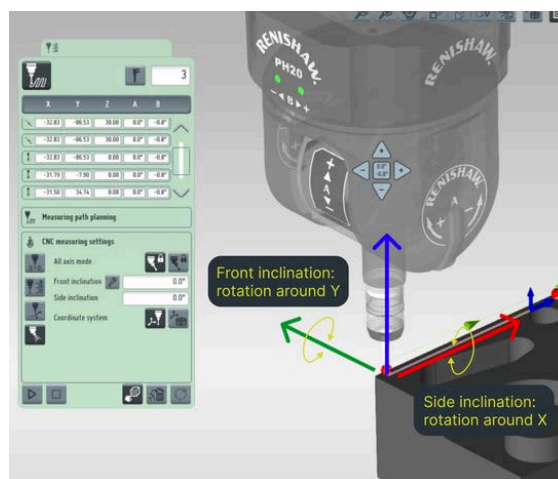

Front inclination and **Side inclination** don't represent the A (Tilt) and B (Rot) angles of the probe head. However, the position of the probe head will be determined by the Front and Side inclination.



















We invite you to check all details and additional information in the WebHelp of the Release 10



Additional information - FYI

New language available

TouchDMIS now supports the following languages:

-  Czech
-  German
-  English
-  Spanish
-  Spanish (Mexican)
-  French
-  Hungarian
-  Polish
-  Italian
-  Japanese
-  Portuguese (Brazilian)
-  Romanian
-  Russian
-  Slovak
-  Serbian
-  Turkish
-  Simplified Chinese
-  Traditional Chinese

**what's new
showcase**





Environment-Friendly Mode

Welcome to the 5.0 transition in TouchDMIS!

With this release, we introduce the **Environment-Friendly Mode**, a sustainability solution for the metrology daily workflow

Now, TouchDMIS and CMM can be set **in stand-by** after a period of inactivity.

In addition, TouchDMIS switches off the air, allowing considerable energy saving
(See *TouchDMIS Automation Control Box*)

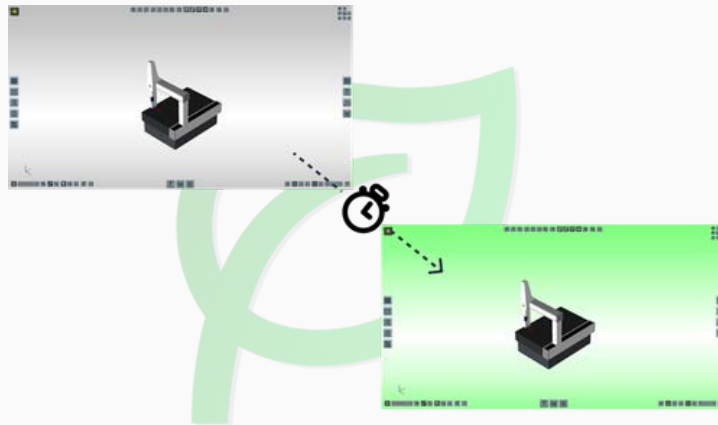

To enable the Environment-Friendly Mode, go to Settings > Automation > Energy Saving and Flag the option.



You can also set after how much TouchDMIS will go into EFM mode and screen-saver background color.

See TD-I1535



Renishaw® REVO integration

Continues our work of integrating different sensors and tools.

Renishaw® REVO is now integrated into TouchDMIS using UCCserver.

Now you can benefit from the high-performance scanning of the REVO head.

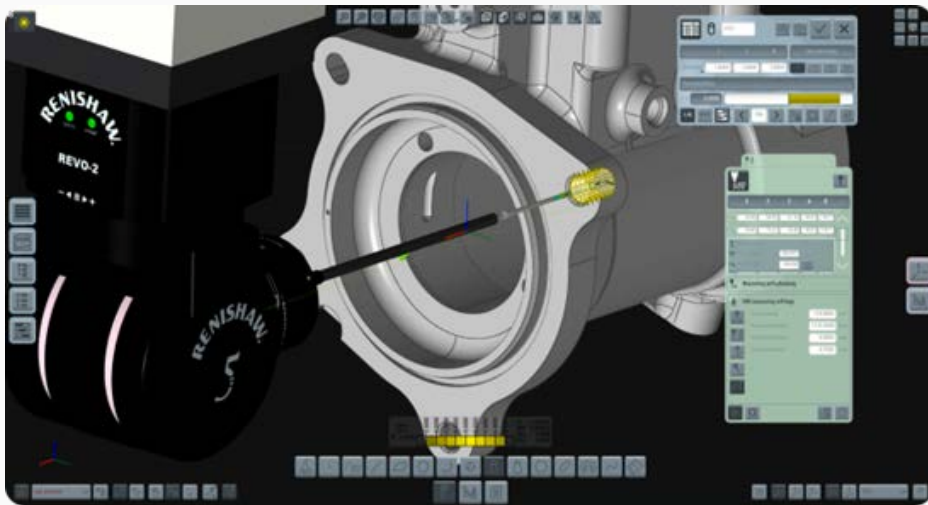

3-axis, 5-axis, helical and sweep scan are now available for all the features, surfaces, and curves included.



See TD-I1518 - TD-I1519 - TD-I1520 - TD-I1251 - TD-I1522 - TD-I1536 - TD-I1539 - TD-I1549 - TD-I1550 - TD-I1551 - TD-I1574 - TD-I1586



Renishaw® Surface Finish Probe SFP2 integration

Renishaw® Surface Finish Probe SFP2 allows TouchDMIS to inspect roughness on components and to produce graphical reports.

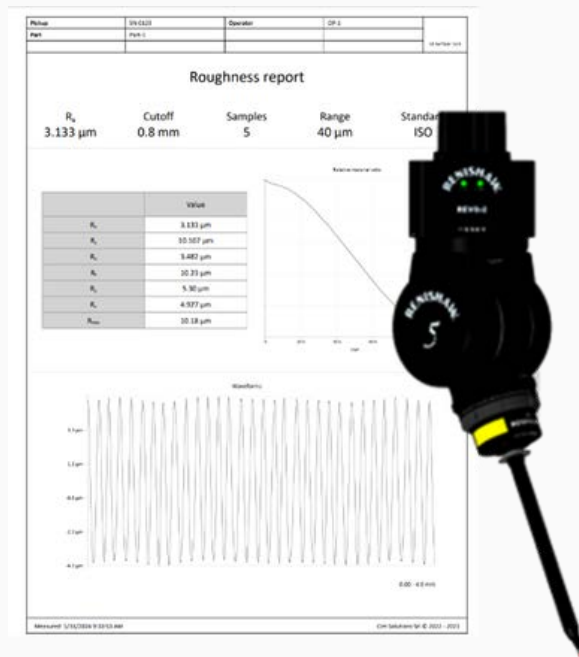

TD-I1572 - TD-I1573 - TD-I1576



PATLITE's signal tower integration

Introducing the technical collaboration with PATLITE, the world's leading manufacturer of signaling and machine lighting devices.

PATLITE LA6-POE series is integrated into the TouchDMIS-CMM infrastructure system, offering **innovative visual** and **audible CMM status feedback**.



The signal towers show the visual status of:

- Program execution
- Output evaluation
- CMM idle status
- CMM machine errors
- TouchDMIS messages (TEXT/OPER and prompts)
- CMM in Environment-Friendly Mode



To configurate PATLITE go to Settings > Automation > Signal Tower, select the model and add the IP address.

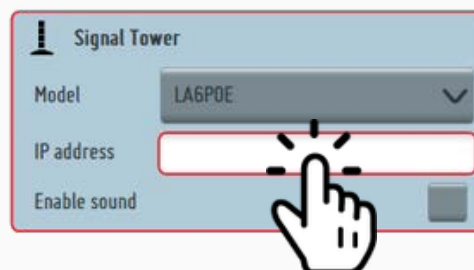

See TD-I1545



Automation devices

Starting with TouchDMIS 9.0, we began integrating a series of automation devices.

These devices enable **improved** and **more efficient** communication between TouchDMIS and external devices, such as **robots, PLCs,** and automation, facilitating the daily workflow.

TouchDMIS Automation Control Box

The TouchDMIS Automatic Control Box integrated into TouchDMIS and Metrology Gate **collects precious CMM information.**

Here is a list of the information provided by the device:

- Air consumption
- Air pressure
- Instant power consumption
- Overall energy usage
- Room temperature and humidity

When TouchDMIS is in **Environment-Friendly Mode**, it **turns off the air when the system is not used**, and **delivers it back when TouchDMIS goes back to work.**

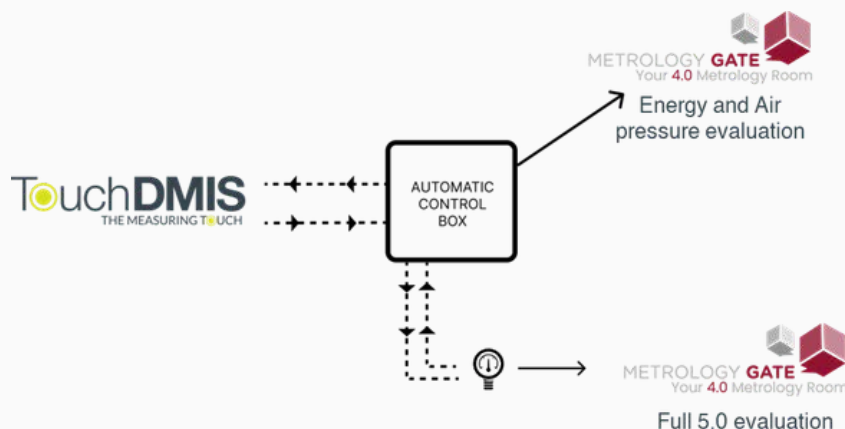

The automation box is **CMM controller independent**, and is installed as a **stand-alone external device.**

See TD-I1552



TesaStar and Hexagon heads integration

We added TesaStar and Hexagon heads in TouchDMIS using TTP mode (I++ server)



See TD-I1524 - TD-I1531

EasyRunner

EasyRunner 3.5 includes fixes and **performance improvements**.

The measuring process can be now **fully automatized with a stand-alone bar code reader** that runs the program by **simply placing the fixture on the machine**.

In addition, a button that **enables seamless execution of the program** has been added.



See-TD-I1596



What's new

GD&T and other improvements

Composite tolerance

Now you can define multiple levels of positional control for patterns of features in TouchDMIS.

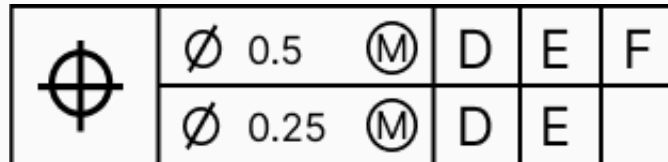

See: TD-I1661 - TD-I1883 - TD-I1887

Show GD&T feature control frame in report labels

We added the possibility to show the GD&T feature control frame into the report labels.

0.0020 A		Parallelism PLN1 A		PCS1 mm, dec	
Tol.Name	Actual	Zone Bonus/	Error	Graph	
T2	0.0611	0.0020	0.0591		

You can add the GD&T feature control frame simply by editing the label through the editor.

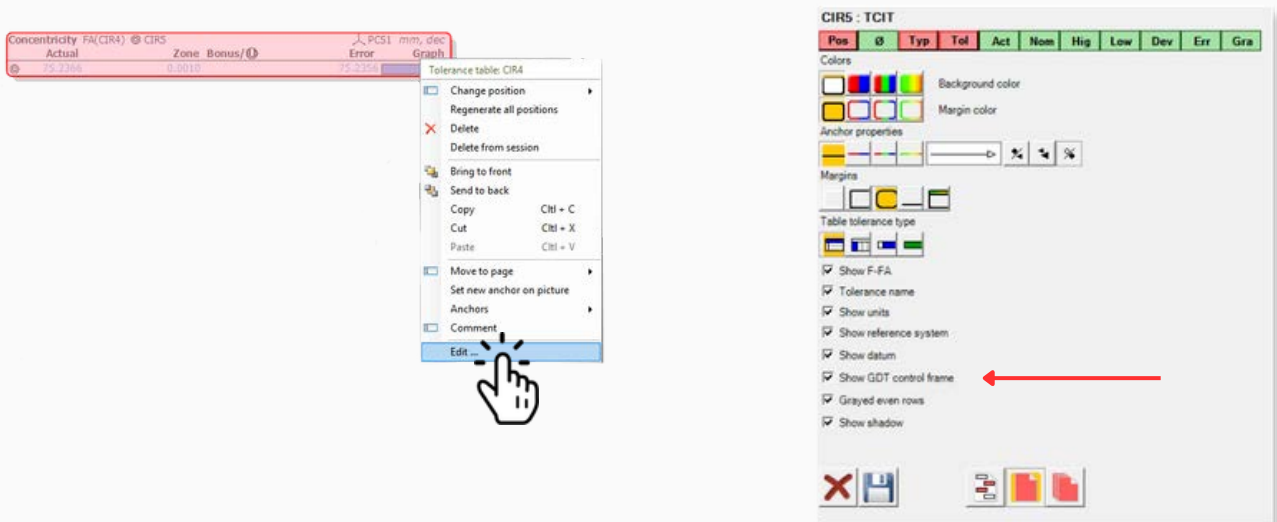

See: TD-I1649



What's new

UI-UX and interface improvements

Prompt improvements

Quick prompt editor for DMIS HLL

We have sped up the inspection workflow by adding a new quick prompt editor in the DMIS editor.

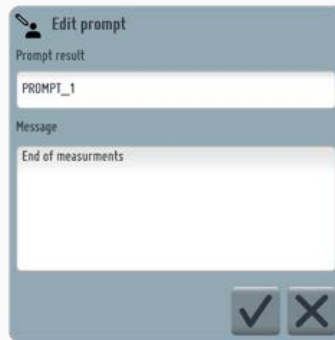

To open the Quick prompt editor go to:

DMIS editor > right-click or press and hold > HLL > Prompt > Single editor

Prompt image size

Now pictures in prompt have its original size and can be easily edited from Prompt editor or code (Title and image size)

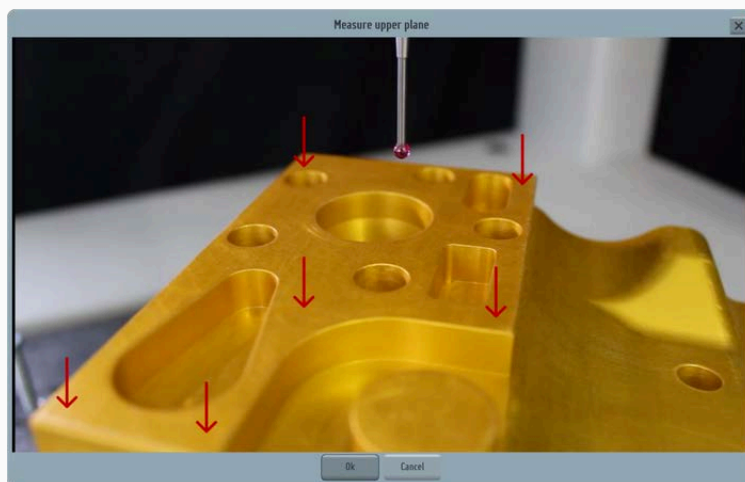

```
PROMPT/0,0,1920,1080,TITLE,'Measure Upper plane',PICTURE,0,0,1920,1080,'C:\NMS\TouchDMIS\UpperPlane.PNG'
```

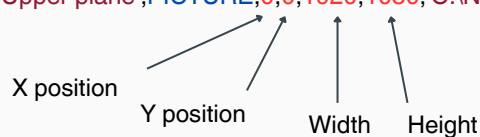

See: TD-I1649 - TD-I2026



What's new

UI-UX and interface improvements

Login authentication through NFC

User profiles functionality is improved and enhanced with NFC functionality.



TouchDMIS can force user authentication with an NFC device making the inspection workflow safer and fully digital.

See TD-I1580 - TD-I1581

New datum icon

We improved the Measuring portal UI by adding the Datum button.



Now you can make alignment, define datum, save and recall coordinate systems in a one-button operation!

See TD-I1658



What's new

UI-UX and interface improvements

Last actions toolbar

TouchDMIS workflow is now faster with a new right toolbar that shows the last 5 actions made during the session.

In this way, users can also follow the single steps that were previously taken.

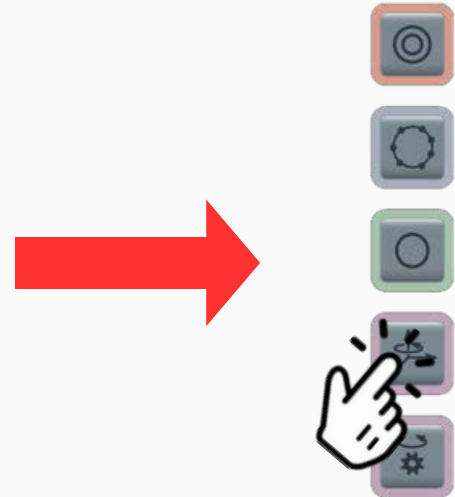

See TD-I1673

Pattern construction implementation

Pattern constructions are now implemented in TouchDMIS!



Now you can build patterns from the Construction toolbar and use them for composite tolerance.

See TD-I1654 - TD-I1672



GD&T feature control frame UI

We have improved the TouchDMIS UI by adding the feature control frame in the Tolerance windows, with the aim of helping operators with GD&T applications.



Before



Now

See TD-I1668



Installation

Check system and hardware requirements

Before installing TouchDMIS, check System and hardware requirements. They can differ from TouchDMIS versions.

To check your PC's properties, go to **This PC** icon, right-click and select **Properties**.

To check the display properties for the GPU, go to **Control Panel** of your PC, and select **Display and Settings**.

TouchDMIS License

You need a valide license through the dongle USB.

In case you dont' have the dongle USB, please contact your distributor.



Administrator user

To install and run TouchDMIS for the first time, you must be logged on as user with Administrator privileges.



Installation

Backup of the machine configuration

In case of re-installation or update of the TouchDMIS version, we suggest to make a backup copy of the machine configuration (*.mcz).

You can save a backup copy of the existing machine configuration in **Settings -> Machine -> Export settings**



First installation

In Administrator mode, run TouchDMIS exe file.



TouchDMIS installation window will appear.





Installation

Install drivers

To install additional drivers, select **Install Drivers**.



Select the drivers from the list and click **Back**.



Update TouchDMIS current version

Run the TouchDMIS exe file. If a another version of TouchDMIS is installed, the setup will uninstall it first, and then proceed with the current installation. We suggest to save a copy of the previous TouchDMIS sessions to a backup folder.

TouchDMIS User manual

Once TouchDMIS is installed, to see the user manual go to **Home -> Help -> View help**

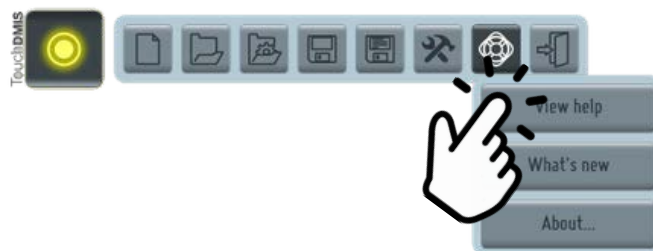

**what we have
integrated,
improved, and
refactored**





What we have integrated, improved, and refactored

Integrations: sensors and tools

TD-I1518 – TD-I1519 – TD-I1520 – TD-I1521 – TD-I1522 – TD-I1536 - TD-I1539 – TD-1549 - TD-I1550 – TD-I1551 – TD-I1574 – TD-I1575 - TD-I1586 - Renishaw® REVO integration
TD-I1524 - TD-I1531 - Added TesaStar and Hexagon heads in TouchDMIS using TTP (I++ Server)
TD-I1535 - TD-I1579 - Energy saving mode (“Environment-Friendly Mode”)
TD-I1545 - TD-I1624 - TD-I1647 - PATLITE signal tower integration in TouchDMIS
TD-I1572 - TD-I1573 - TD-I1576 - Renishaw® SFP2 integration

Integrations: automation

TD-I1552 - “TouchDMIS Automation Control Box” implementation
TD-I1580 - TD-I1581 - Added NFC authentication for user profiles

Improvements

TD-I1003 - Added a setting to enable the safe position during tool changing
TD-I1014 - Implementation of selection of S/SA during localization of calibration objects
TD-I1511 - Improved TouchDMIS startup time
TD-I1523 - TD-I1532 - TD-I1533 - Improved all-axis touch measurement
TD-I1529 - Implementation of PATH/SURFACE statement
TD-I1565 - Changer rack - Improved support design
TD-I1594 - TD-I1595 - TD-I1596 - TD-I1608 - TD-I1610 - Improved EasyRunner performance: added bar code scanner functionality and option to enable seamless execution of the measuring programs
TD-I1600 - Improved scanning retrieving points velocity
TD-I1621 - Improved Machine setup interface
TD-I1627 - Implementation of the Metrology Gate variables through the command DMESW/COMAND,'HEADERMACRODIALOG'
TD-I1631 - Added GD&T feature control frame to tabulated and graphical report



What we have integrated, improved, and refactored

- TD-I1633** - Pantec: now the approach distance is calculated from the surface of the sensor
- TD-I1649 - TD-I2026** - Prompt improvements: Added the Quick prompt editor for DMIS HLL and the possibility to edit the picture size
- TD-I1654 - TD-I1672** - Pattern construction implementation
- TD-I1653** - Improved slot measurement angles using arc
- TD-I1658** - Moved Datum/Alignment icon in the Measuring portal
- TD-I1661 - TD-I1867 - TD-I1883 - TD-I1887** - Integration of composite tolerance
- TD-I1662** - RDS Arm measure confirmation buttons
- TD-I1667** - Improved GD&T windows in main interface
- TD-I1668** - Added GD&T Feature control frame in Datum window
- TD-I1670 - TD-I1671** - Improvements in datum application
- TD-I1673** - “Last actions” functionality improved
- TD-I1686** - Improved translations in graphical reporting
- TD-I1695** - Gear plugin: improved gear model visualization
- TD-I1708 - TD-I1724 - TD-I1730** - Improved changer rack procedure: adding coupling and sweep speed, changing the port status, and improving the dialog box
- TD-I1776** - CC3/2: Restored axes block buttons (F11 - F12 - F13)
- TD-I1818** - Added a confirmation prompt before the changer rack alignment process starts
- TD-I1859** - Added a confirmation prompt before executing FROM-HOME
- TD-I1884** - Improved RDS arm visualization
- TD-I1893** - Added the possibility to use the auto calculation of elevation angle from IPP
- TD-I1908** - Fixed error in scanning acceleration not working on path line
- TD-I1927** - Pantec: fixed circle scanning and approach move to scan
- TD-I1952** - GEAR plugin: added DELETE/F () command
- TD-I1993** - Refactoring of the error messages on critical hardware errors
- TD-I2004** - Implementation of the DMIS command SMODE()
- TD-I2074** - Improved point cloud construction calculation

what's new in Service Pack 1





Service Pack 1

Changes and improvements in SP1

Alignments and equate CAD

SP1 introduces some little but important changes to alignment user experience. We set the Equate CAD button active by default during the Locate and RPS alignment. Equate on CAD will only be applied based on user instruction.



Don't forget all the datums!
The 3-2-1 alignment now requires all three datums to be selected to apply and confirm it.

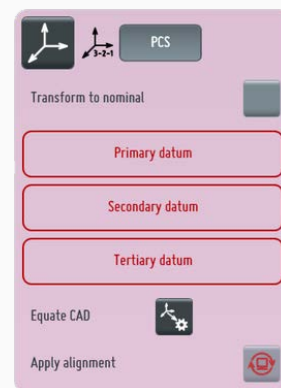

For existing programs, TouchDMIS now automatically checks the code upon opening. If a LOCATE instruction does not have a subsequent EQUATE, the system automatically adds it, maintaining full compatibility with previous measurement routines.

TD-I2153 - TD-I2157 - TD-I2160

Improved color and contrast in textbox fields

We improved color and contrast in textbox fields in editing mode.

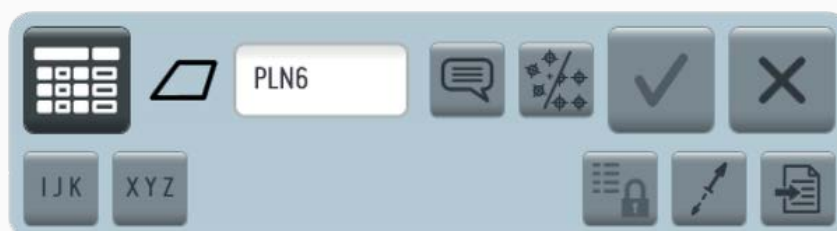

TD-I2110



Service Pack 1

Changes and improvements in SP1

Check for A negative angles in HEADCS

Due to compatibility with newer version of TouchDMIS, SP1 introduces a DMIS check-read that warns user if the part program contains A negative angle in HEADCS.

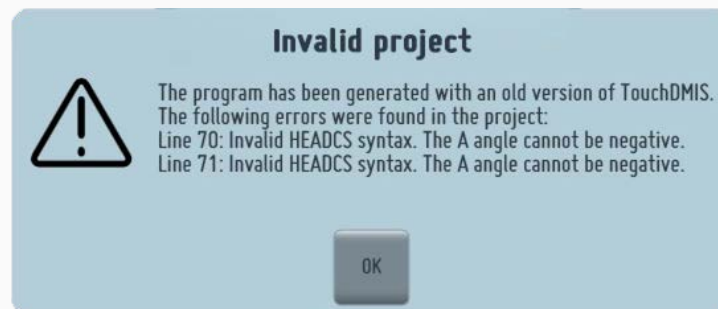

TD-I2159

CALL/EXTERN syntax

Now, correct syntax for CALL/EXTERN statement is:

```
CALL/EXTERN,DMIS,M(macro_name),'{string_param}',{numeric_param}
```

TD-I1601



Service Pack 1

Changes and improvements in SP1

Improvements

TD-I2110 - Improved color and contrast in textbox fields

TD-I2113 - Improved Clearance/Depth windows interface and disabled "Project all points" option when more than one plane is selected

TD-I2153 - Avoid applying 3-2-1 alignment if not all three datum are selected

TD-I2157 - Equate CAD button set by default in RPS and Best-fit alignment

TD-I2159 - Pre-Process DMIS for HEADCS negative angles

TD-I2160 - Pre-Process DMIS for missing EQUATE after LOCATE

TD-I2206 - Syntax of BF construction by points (PTDATA) now can use spaces in the features name

TD-I2243 - Edge point relative measurement improvements: set radius and offset parameters

fixed bugs





Fixed bugs

This release addressed the following bugs:

- TD-I83** - PH20 - Fixed error in measurement path generation when angle is edited
- TD-I1215** - Fixed the wrong best-fit plane
- TD-I1242** - Error during the re-execution of an edited measurement block
- TD-I1357** - Fixed error during the manual head implementation in TTP
- TD-I1387** - **TD-I1647** - Fixed fail to import some CAD models, now restored
- TD-I1388** - Fixed error when using the MH20 that prevents the creation of new tools
- TD-I1390** - Fixed error when selecting plane edge planning method using continuous scanning
- TD-I1451** - Fixed error during changer rack procedure: TouchDMIS goes down after “Controller refused to execute requested command” message
- TD-I1508** - Fixed the wrong form error and deviation of cone measurement
- TD-I1517** - PH20 - GoTo’s error during the measurement of the outer circle
- TD-I1534** - TouchDMIS goes down after setting a star probe and selecting another tool
- TD-I1537** - Changer rack - Wrong TSR-10 offset from port 6 to 10
- TD-I1538** - PH20: fixed wrong angles using mirror part program
- TD-I1540** - PH20 - standard 3-axis GoTo after SNSLCT with probe orientation rotate it back to 0,0
- TD-I1542** - Graphical report - Fixed missing callout and lines in output
- TD-I1541** - Fixed errors in actual probe compensation using UCCServer
- TD-I1543** - Fixed the error that if setting a small diameter of an outer circle in HEADCS, TouchDMIS shows “Feature too small” error message
- TD-I1544** - Fixed the shutdown with no message in case TouchDMIS with no license
- TD-I1546** - Fixed the wrong graphical representation of horizontal CMMs
- TD-I1547** - Changer rack - TouchDMIS shows a message to load the subassembly in the rack even if it is already loaded
- TD-I1558** - Fixed error of saving uncompleted probes
- TD-I1565** - Fixed design error in FCR25 rack representation
- TD-I1571** - Changer rack - Fixed wrong subassembly suggestion
- TD-I1583** - Mixing single point and scan with ARM gives wrong results to probe compensation
- TD-I1591** - Error in feature name during the construction of a line
- TD-I1600** - CC3 - Fixed error in calibration routine using MH20i head



Fixed bugs

- TD-I1602** - Fixed error in report template: wrong text button and behavior
- TD-I1618** - The OBTAIN applied to the surface points asking for i,j,k always returns 0
- TD-I1623** - PH10 - Fixed error after calibration using NMC300: Probe moves without sensor confirmation even in MAN mode
- TD-I1628** - Fixed error in GoTo PCS: first PTMEAS is executed with wrong head orientation
- TD-I1630** - Changer rack: fixed error during calibration routine
- TD-I1632** - Fixed error in importing old version of the STEP file
- TD-I1637** - Graphical Report: fixed the error in the position of the anchors
- TD-I1644** - PH20 - Wrong probe head orientation after 5-axis GoTo
- TD-I1650** - Fixed error in scanning path using only 2 points
- TD-I1659** - Fixed error in measuring after a dry run execution
- TD-I1663** - RDS Arm - Fixed error while selecting the laser on RDS App
- TD-I1665** - UCCserver: fixed error in TouchDMIS with some PH20 calibrated position
- TD-I1666** - Lost depth settings after changing speed value on the measuring window
- TD-I1669** - Fixed error in the application of position tolerance (after the definition of the position tolerance, the dialog does not include the tolerance value)
- TD-I1676** - Fixed error in Line as center line construction: the result is wrong in the execution
- TD-I1681** - Fixed error in Line as copy construction: the result is wrong in the execution
- TD-I1682** - Fixed error in Plane as copy construction (the construction of the plane has wrong values)
- TD-I1687** - Fixed error in Plane as sphere offset construction (impossible to confirm the construction of a plane as sphere offset)
- TD-I1689** - Fixed error in Sphere as copy construction: the result is wrong in the execution
- TD-I1691** - Fixed error in measurement of circles using HEADCS
- TD-I1692** - **TD-I1693** GEAR plugin: fixed errors in pitch, thickness, and runout evaluation
- TD-I1696** - GEAR plugin: fixed error in saving nominal gear file
- TD-I1688** - Fixed error in Plane as plane translation construction (the construction of a plane as plane translation has a wrong nominal value, and the value is only positive)
- TD-I1712** - Fixed error in the application of the position tolerance using planes: values were not displayed in the results window



Fixed bugs

TD-I1772 - Chager rack - Fixed SSR rack configuration (SP25 allowed to rack SSR20)

TD-I1780 - Fixed connection errors using PMT

TD-I1800 - Fixed the error in the renaming of the feature construction

TD-I1802 - Fixed errors in 2D and 3D labels

TD-I1813 - Fixed error while applying ISO \emptyset tolerance on multiple objects (it applies tolerance only for the first object)

TD-I1830 - Fixed errors in distance between lines

TD-I1831 - Fixed error while measuring using a manual machine with swap axes: TouchDMIS gives an error

TD-I1841 - Fixed measure out of volume error while scanning arcs

TD-I1854 - Fixed error while selecting line limits

TD-I1859 - Fixed error in editing measuring path with cylinder (cannot drag the beginning and end of sections)

TD-I1879 - Fixed component rack configuration (impossible to assign a component to a rack)

TD-I1890 - GEAR plugin - Fixed \pm selection bug in the Gear parameters dialog box

TD-I1911 - Fixed error on play button disabled during measurement interruption

TD-I1925 - Fixed errors after connect/disconnect button pressed: the probe and controller has different probes

TD-I1945 - Fixed cone measurement error form

TD-I1950 - Fixed errors on scan on curve: TouchDMIS allows the creation of scan on curve with only 2 points (3 needed)

TD-I1951 - GEAR plugin: fixed errors when measuring single points, but scan mode is still active

TD-I1953 - GEAR plugin - Fixed error in selecting tool for alignment

TD-I2077 - Fixed error when selecting cylinder feature: the direction is inverted

TD-I2080 - Fixed error when applying negative tolerance on surface using EN ISO (UZ)

TD-I2082 - Fixed error on inverted measuring path when selecting a surface

TD-I2083 - ASME and EN ISO [UZ] tolerances: fixed wrong results

TD-I2091 - Fixed error in construction: Impossible to make a line through two lines

TD-I2094 - Fixed alignment error that gives synthax error after creating an alignment between a plane and two slots (or a circle and a slot)

fixed bugs in Service Pack 1





Service Pack 1

TouchDMIS 10 SP1 addressed the following bugs:

TD-I1564 - Fixed error in GoTo delta calculation: by applying delta values, cursor moves to PCS

TD-I1601 - Fixed not working CALL/EXTERN syntax

TD-I2097 - Fixed error in best-fit construction: When the name of the BESTFIT element is changed, and no change is made on the features or points, the name is not updated in the construction generation

TD-I2105 - Fixed error in UI portals: in some case the selection of mesh/laser environment TouchDMIS crashes

TD-I2117 - REVO - Fixed error using custom front inclination on circles: after accepting the measurement during the re-execution the angles are switch to default

TD-I2152 - Fixed error while edit a plane using the Block view mode: points will be lost after the second execution

TD-I2158 - Fixed error using the head touch mode method with circles

TD-I2167 - 5-axis - Fixed error on Head touch behavior on holes measurements

TD-I2173 - Changer rack - Fixed error while using non-indexable heads: change tool procedure fails

TD-I2177 - Fixed wrong 2D position with single datum

TD-I2179 - Fixed error in slot construction procedure

TD-I2184 - Fixed error using perpendicularity tolerance: wrong values when selecting a plane with two datums

TD-I2188 - Easy Runner - Fixed the error where the “File not found” message appears

TD-I2192 - Fixed error in BF syntax: in case of BF syntax, the block is no longer considered as a construction block but a High Level block, so the element cannot be seen in data

TD-I2207 - Fixed crash error while selecting a probe in the TreeView window

TD-I2216 - Fixed error on construction of line through points: feature name is different in the DMIS editor

TD-I2219 - Fixed error while executing parallelism between cylinders

TD-I2220 - Fixed error in points export: the point export does not follow the PRCOMP ON/OFF rule



Service Pack 1

TD-I2221 - Fixed error using 5-axes: using Head touch mode for inner circle moves the head

TD-I2228 - PH20 - Fixed error using “Static mode”: the probe orientation seems to be recalculated hist for PTMEAS while GOTOs have fixed angle

TD-I2233 - 5-axis - Fixed error using Head touch mode with outer circle: first GoTo inside outer circle generates error

TD-I2240 - **TD-I2241** - Fixed errors in the retracted ram during tool changes that could have caused collisions in some cases

TD-I2242 - Fixed error in report: when loading a project with a form error the labels are missing

TD-I2252 - Fixed error in plane form error: the result is different while using the automatic feature detection

TD-I2257 - Fixed error in RMEAS on feature with tool change

**supported
hardware, drivers
and changer racks**





Supported Hardware & Drivers

Here is the complete list of TouchDMIS-Controller compatibility and its latest driver version.

System	Firmware/driver/software version
UCC 2-2, T3, T5, S3, S5	UCCserver 5.10.x
Pantec	Available
CC3	V.3.87
DEVA 004	Devacmmctrl61
DEVA Manual (DEVA 001 + DEVA 0037)	Devacmmctrl61
HEXAGON ARMS	Infinite arm RDS 4.x, Absolute arm RDS 5.x
FARO arms: Platinum, Edge	Faro arm Driver Bundle 6.6.0.15
AX3 (unit for man, CMMs)	AX3_V4ND_4.10
LK MCC NMC	Firmware nmc300_36
GRAPHICAL SIMULATOR	Available
API laser tracker: Radian, OTII	SDK RadianPlus-OmniTrackII 5.17.6 (Radian Pro 4.24.16.1)
RD77	Available
IMUSB-100 MH	Release January 2018
PMT arms	3.0.5.1E



Supported changer racks

LK series

MSR20-3

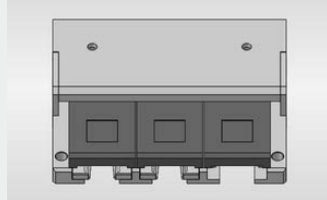

MSR25

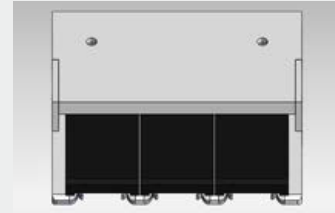

TSR-5

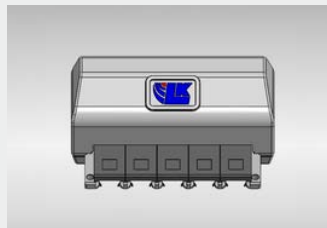

TSR-10

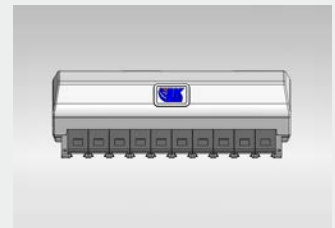

SSR25-3

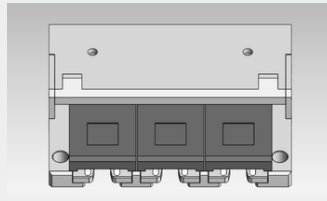

MSR200-3

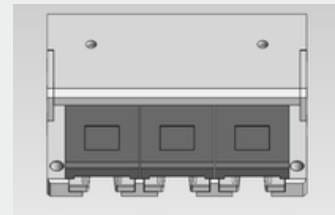

Renishaw series

FCR25

FCR-25L3
FCR-25L6
FCR-25TC



SCR200

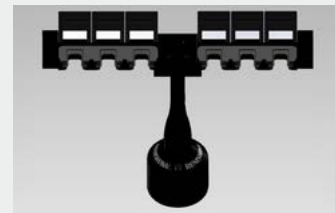

MCR20

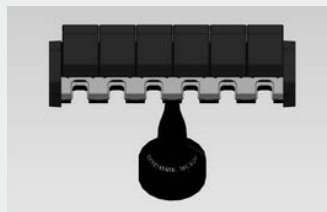

ACR3



PC specifications





PC Specifications

Minimum (manual CMM, small CAD models)

OS	64-bit Windows 10
CPU	Intel Core i5
RAM	8 GB
HARD DRIVE	256 GB SSD
GRAPHICS	2 GB NVIDIA chipset supporting DirectX 11 or higher, feature level 11
USB	2, USB 2.0 - 3.0 (TouchDMIS license key and CMM communication)
MICROSOFT .NET	4.7.2
ETHERNET	1, 100 Base-T Ethernet port (CMM controller)

Recommended (CNC, CMM using CAD or a laser scanner)

OS	64-bit Windows 10, Professional
CPU	Intel Core i7
RAM	16 GB
HARD DRIVE	1 TB SSD
GRAPHICS	4 GB NVIDIA chipset supporting DirectX 11 or Higher, feature level 12
USB	1, USB 2.0 (TouchDMIS license key) or 1 USB (or serial RS232) for systems with PH10 controller
MICROSOFT .NET	4.7.2
ETHERNET	1, 100 Base-T Ethernet port (CMM controller)

contacts and official channels





TouchDMIS contacts and official channels

We take care of our customers and users and try to solve all client problems promptly. Here is a list of contacts and channels based on your TouchDMIS needs.

Direct contacts

info@touchdmis.com

support@touchdmis.com

TouchDMIS official channels

www.touchdmis.com

LinkedIn

YouTube



Copyright 2026 © CIM Solutions Srl

All rights reserved.

The information in this document is subject to change without prior notice and is intended as general information only.

TouchDMIS

THE MEASURING TOUCH



s.o.l.u.t.i.o.n.s